

MAIN FLOOR 580 S.F.

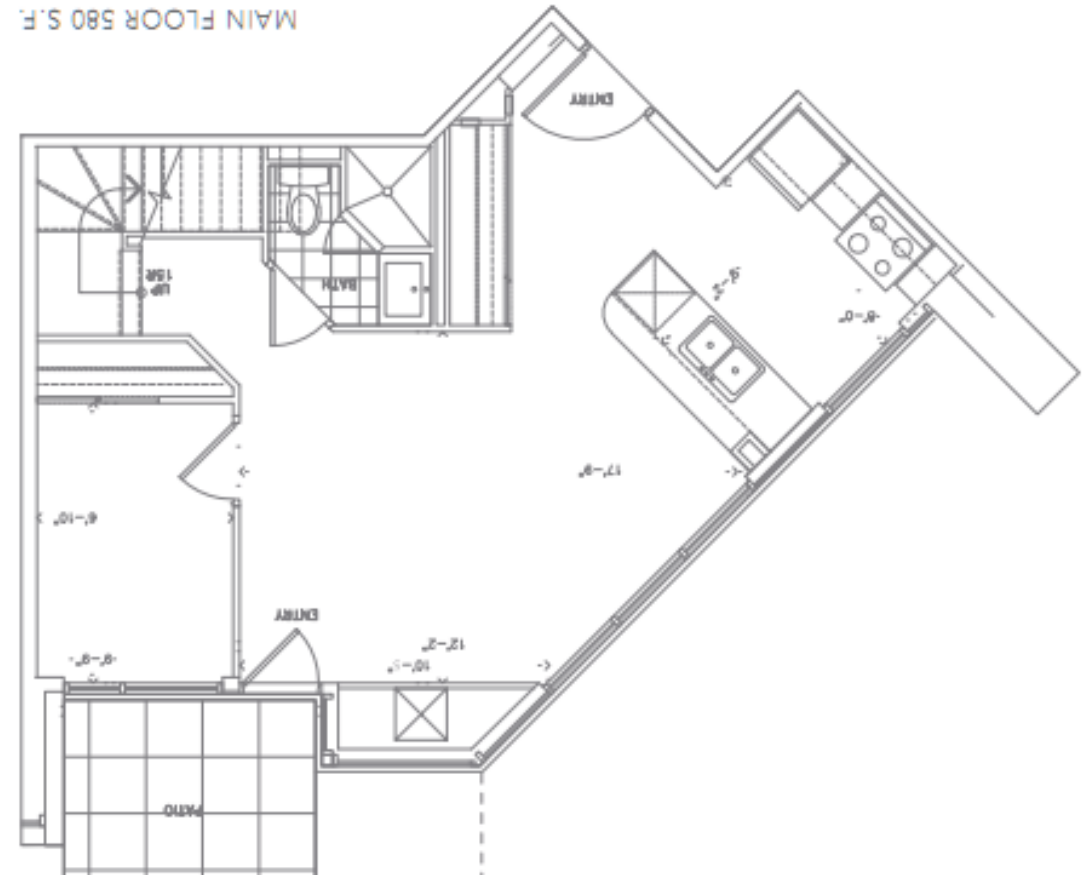

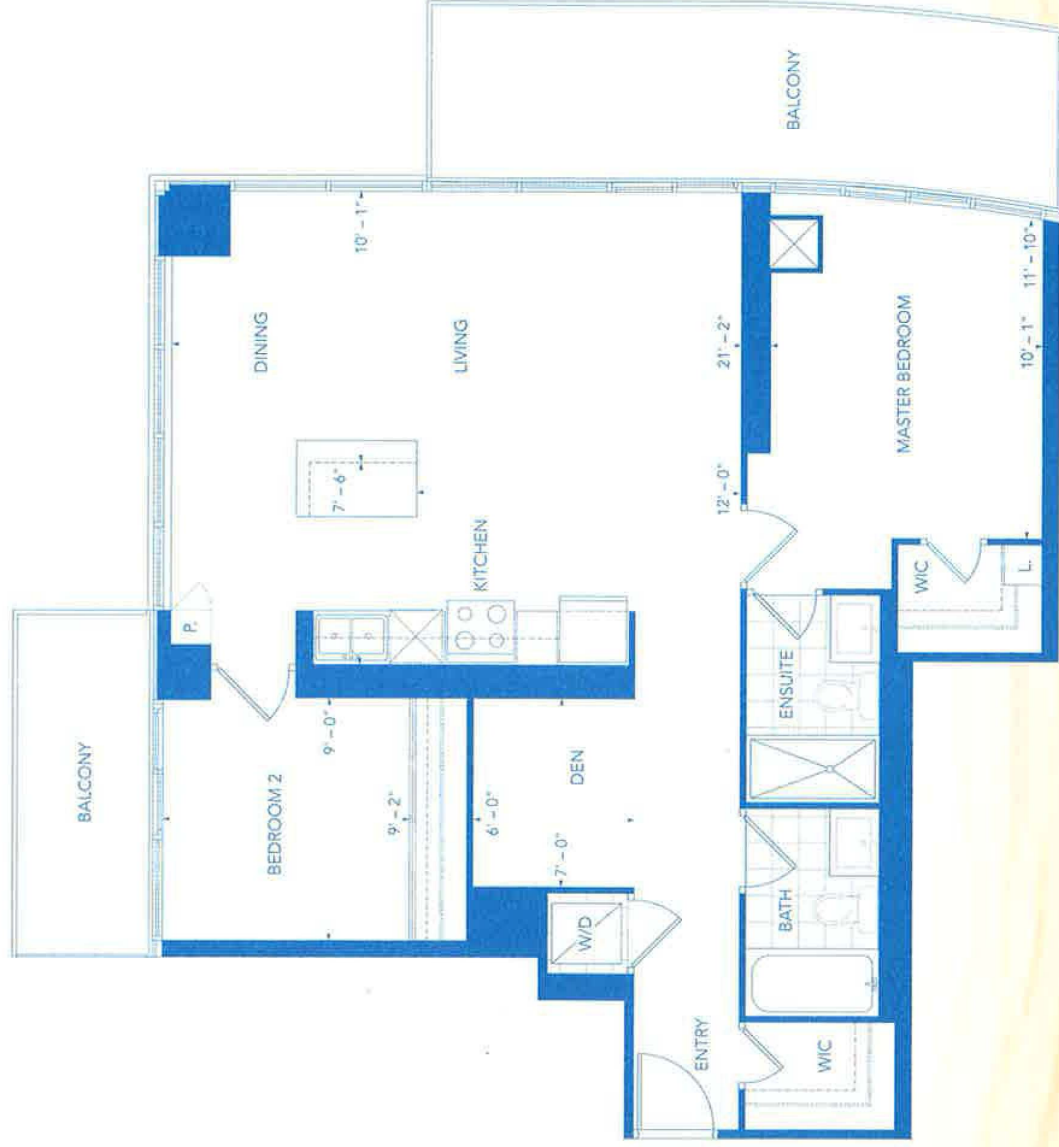



HORIZON 989 SQ.FT.
 2 BEDROOM + DEN (032-A)



FLOORS 10-22

MAIN FLOOR 551 S.F.

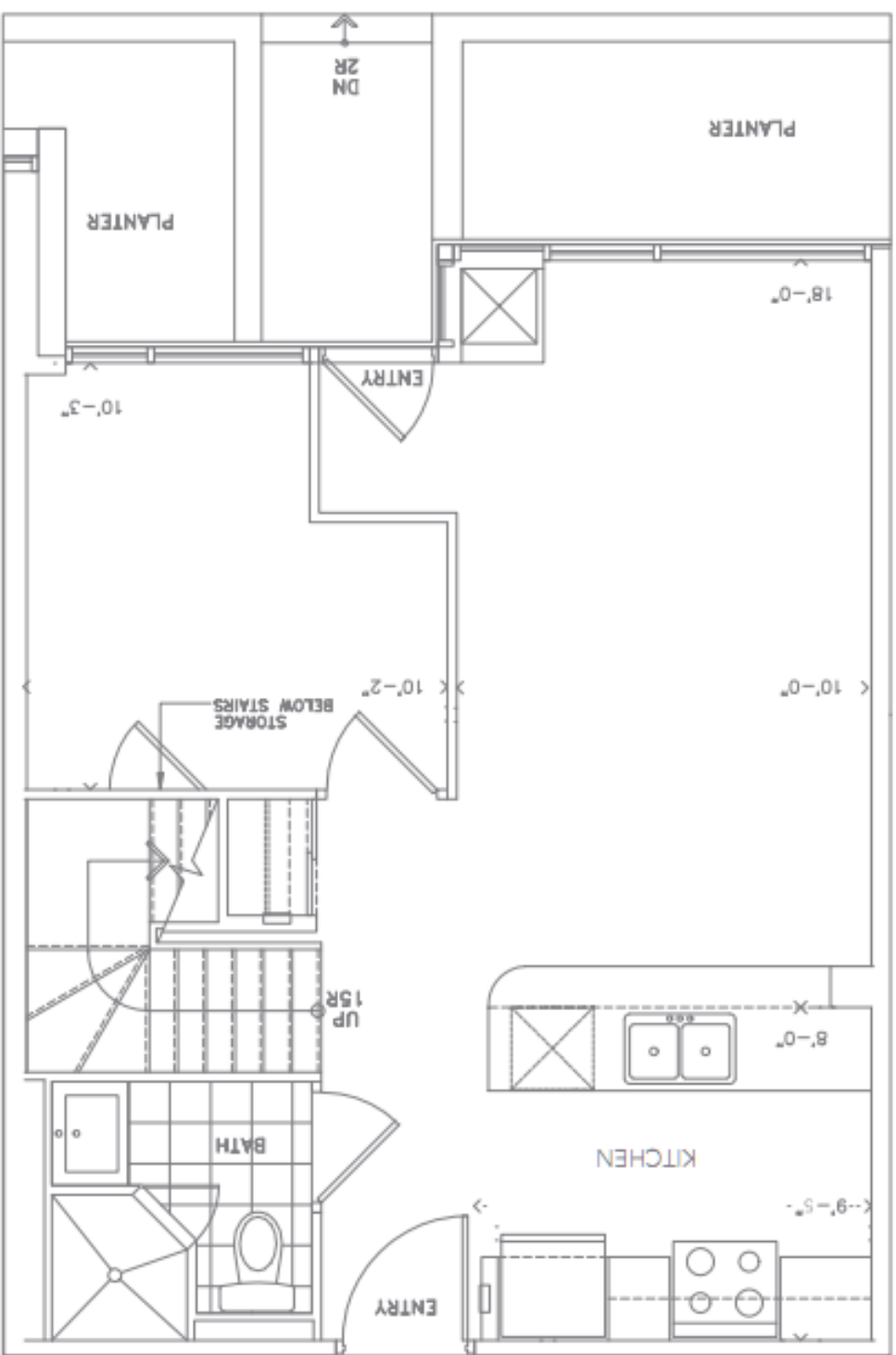

UPPER FLOOR 570 S.F.

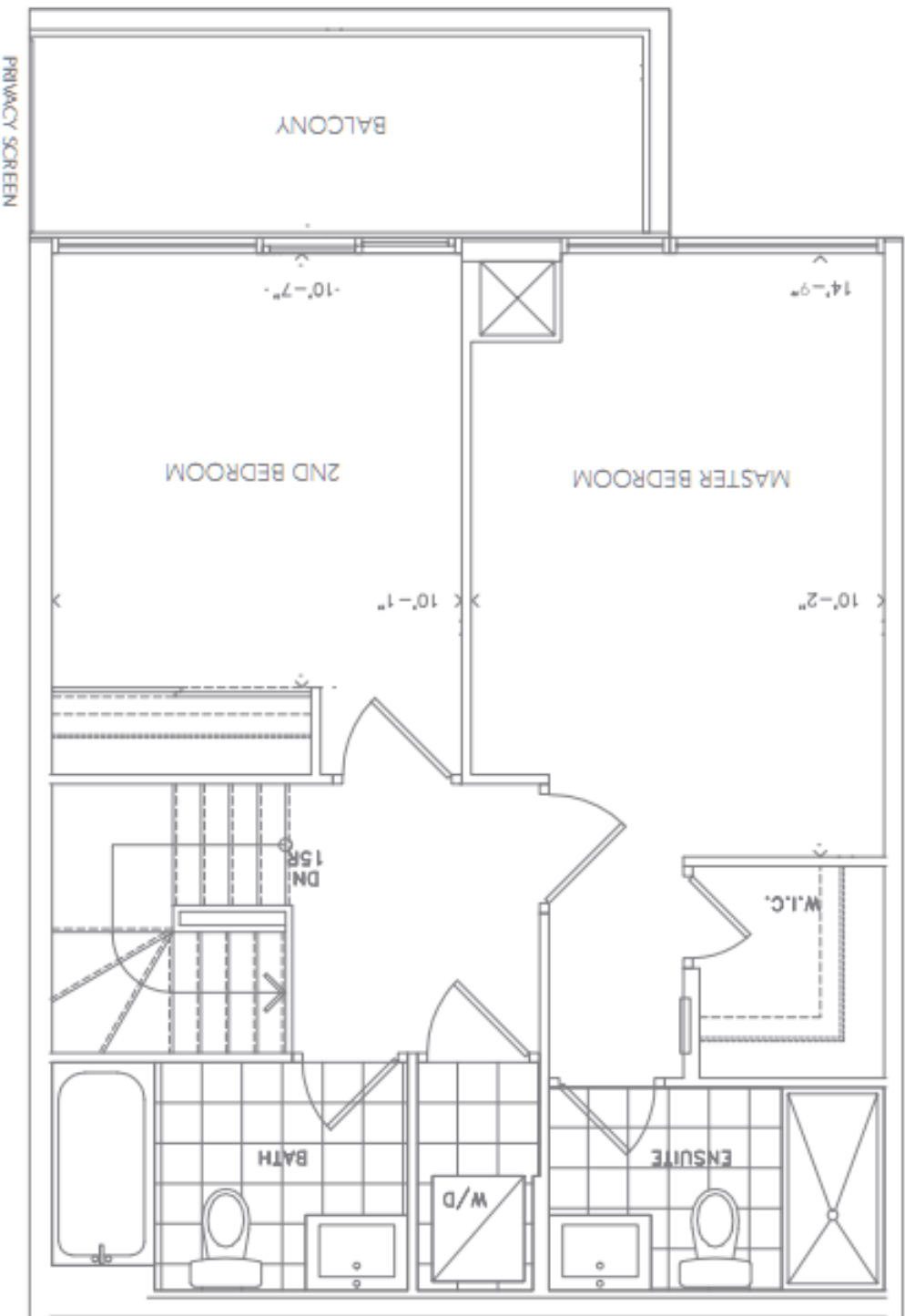

MAIN FLOOR 551 S.F.

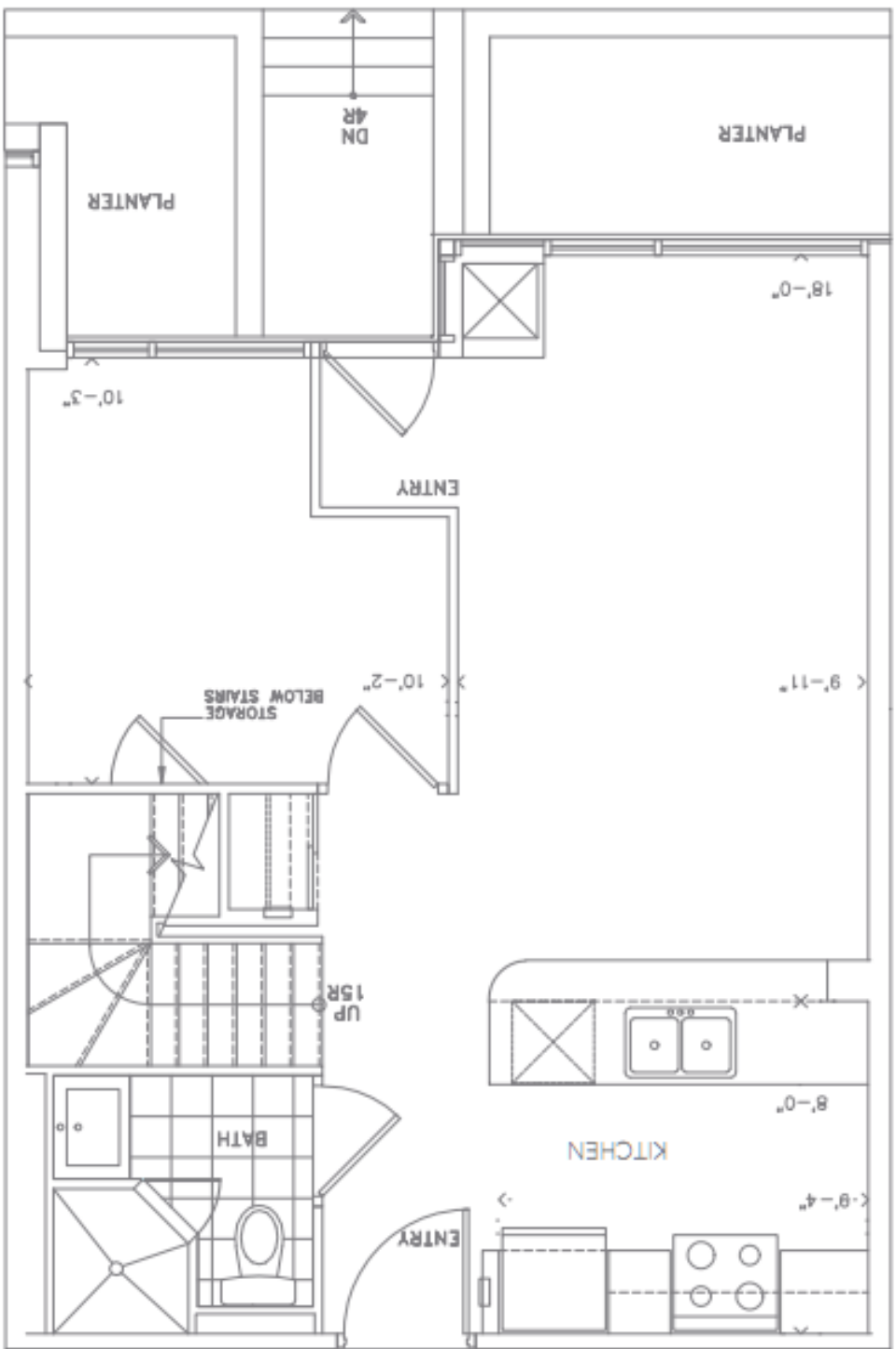

UPPER FLOOR 570 S.F.

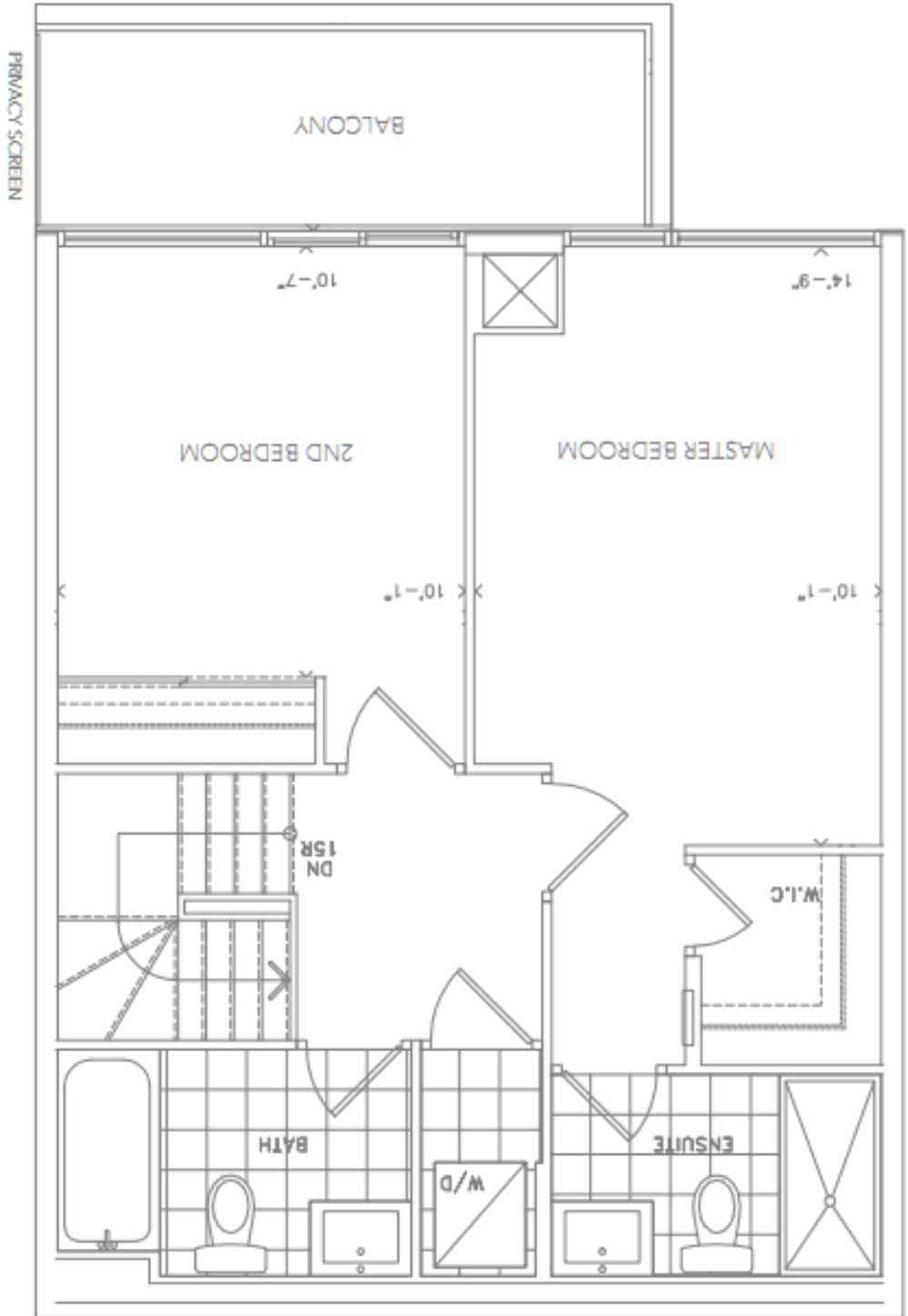



UPPER FLOOR 570 S.F.

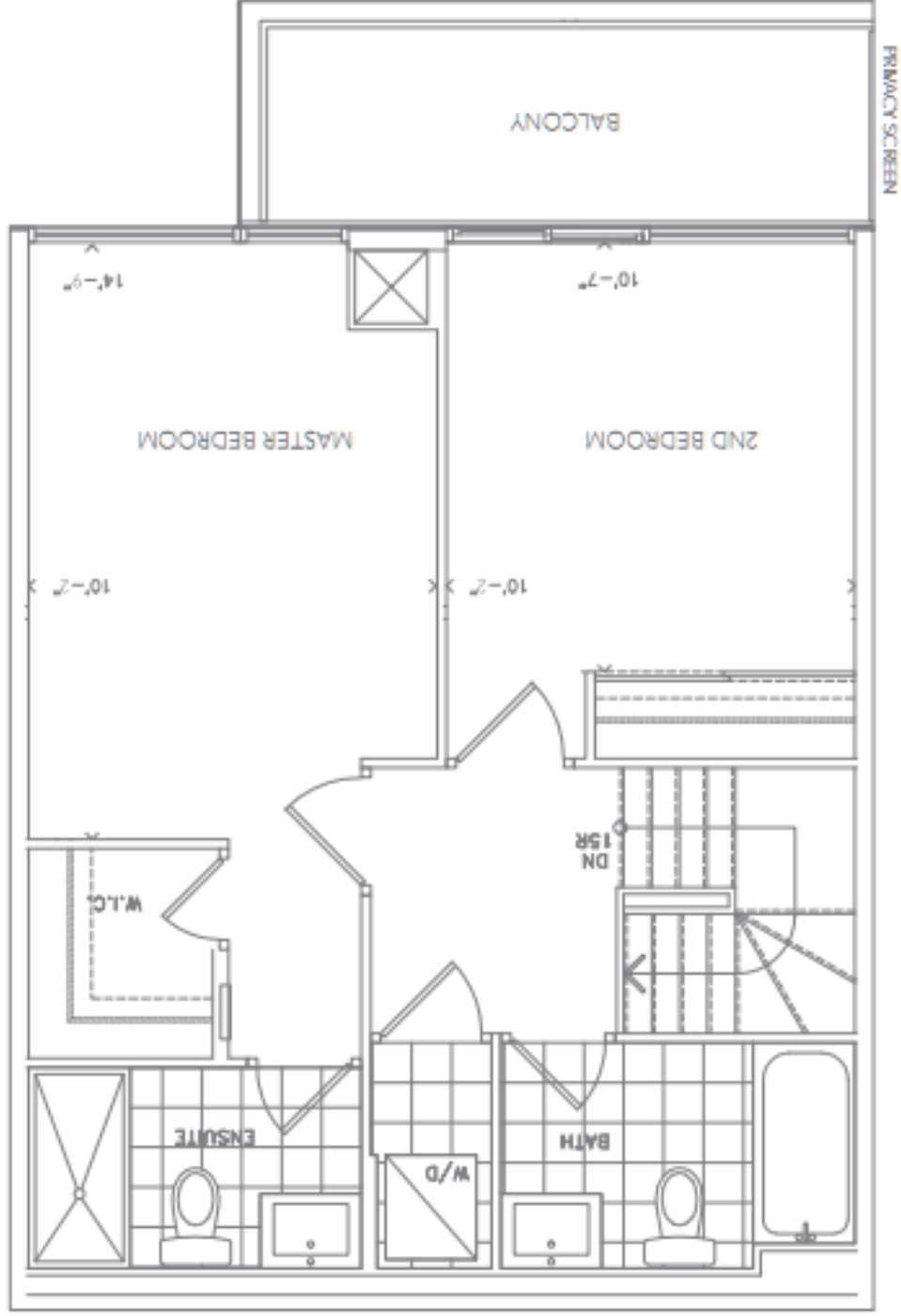

MAIN FLOOR 551 S.F.

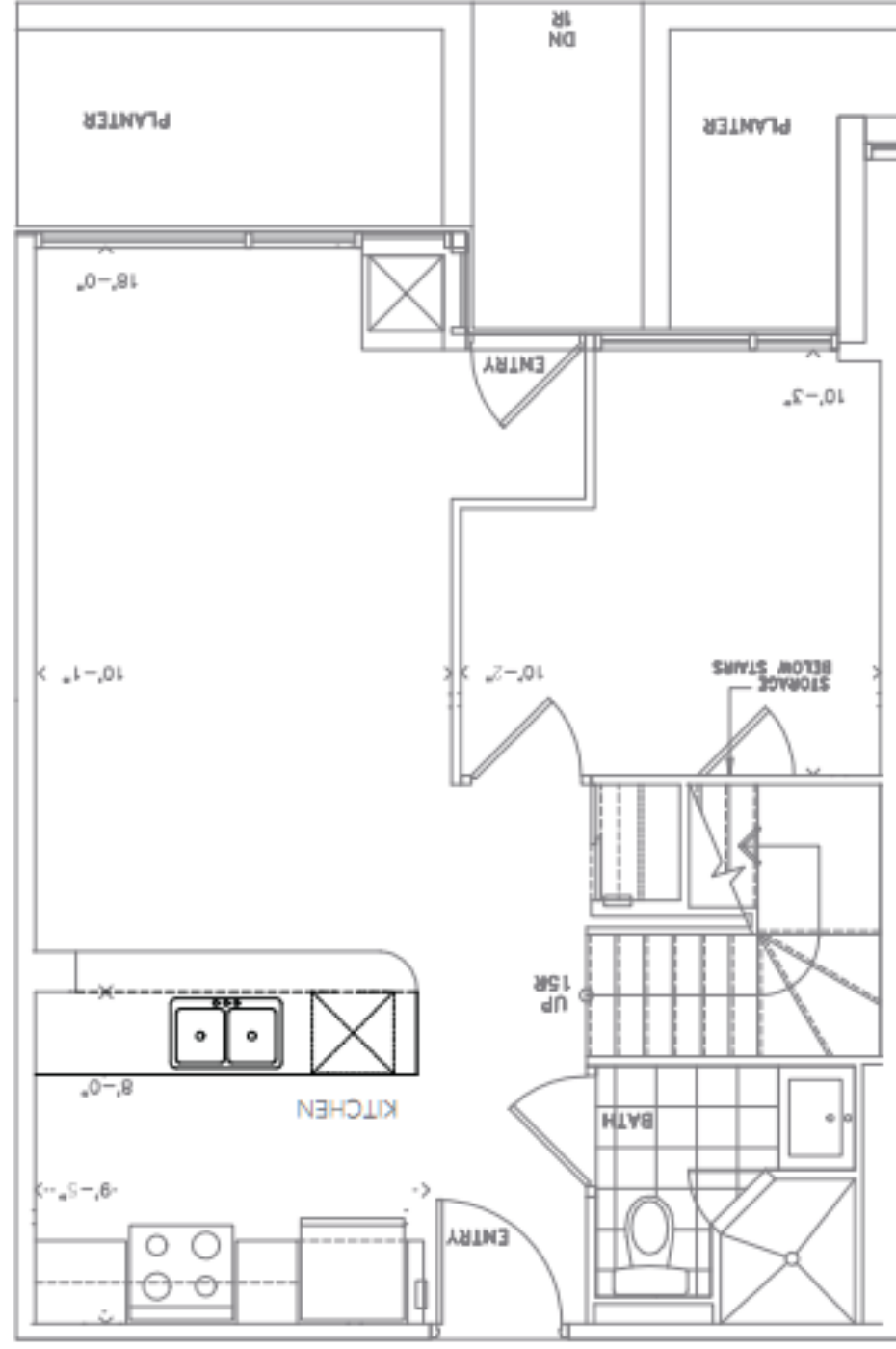

MAIN FLOOR 551 S.F.

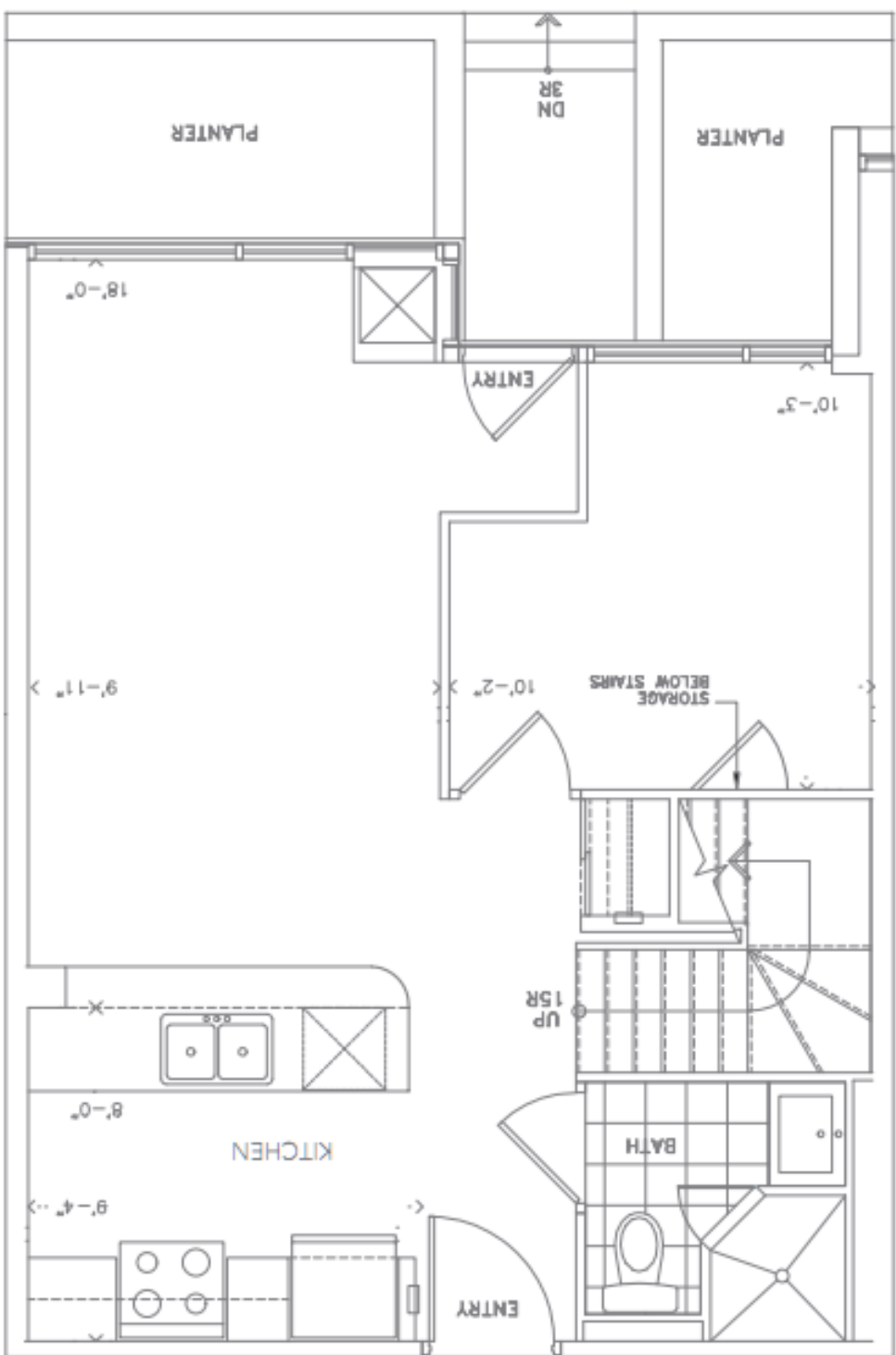

UPPER FLOOR 570 S.F.

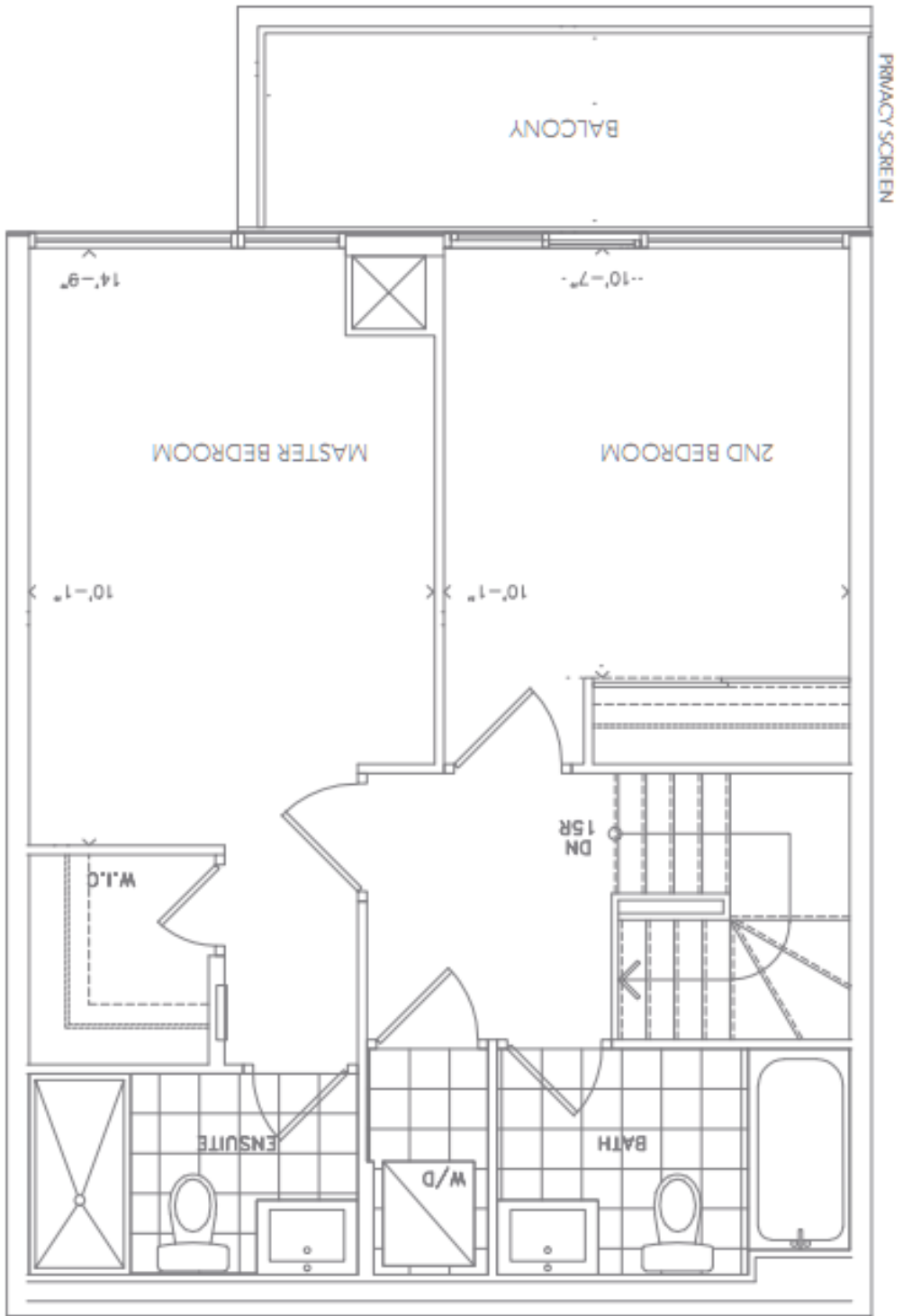





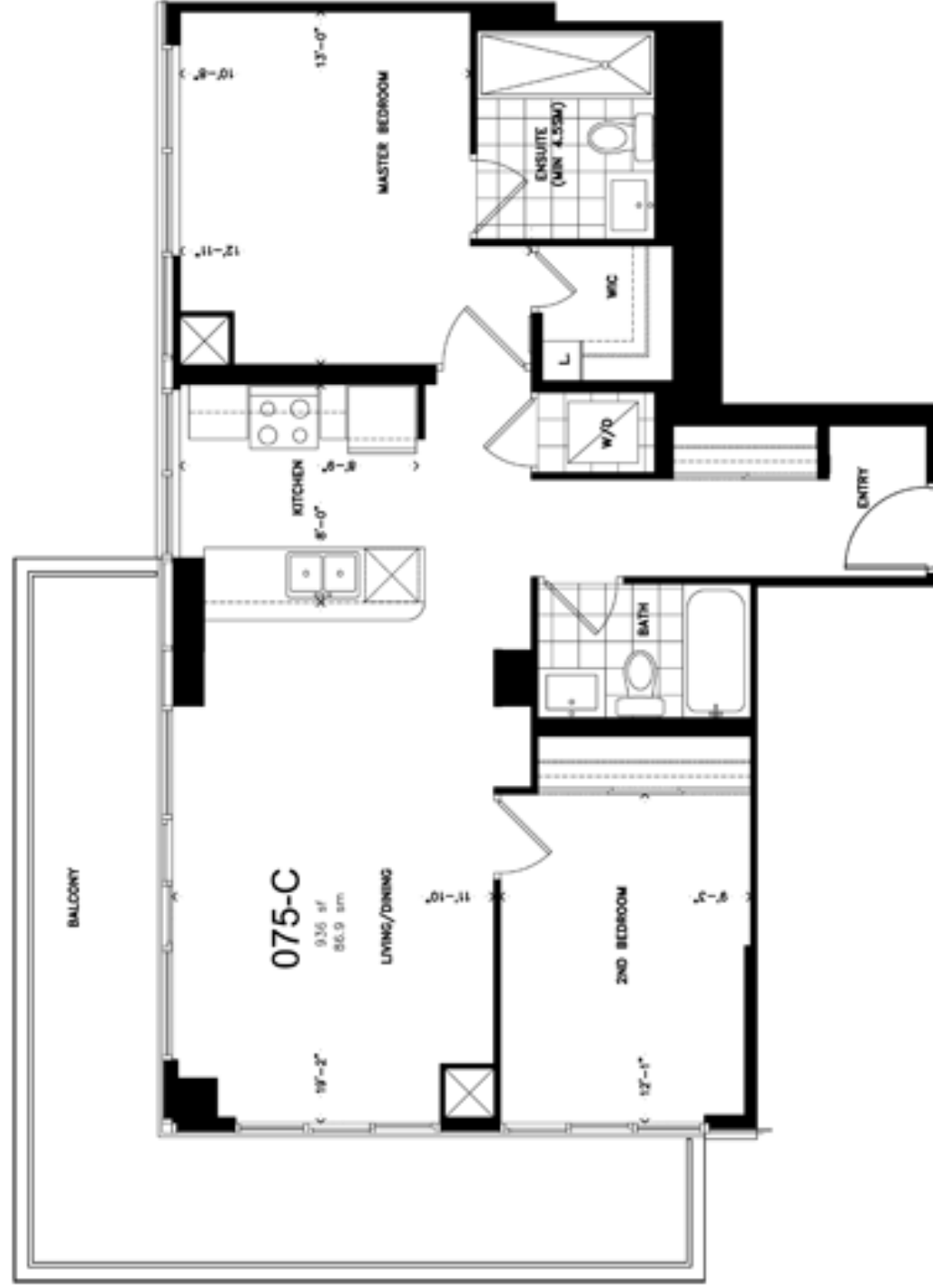





UPPER FLOOR 589 S.F.

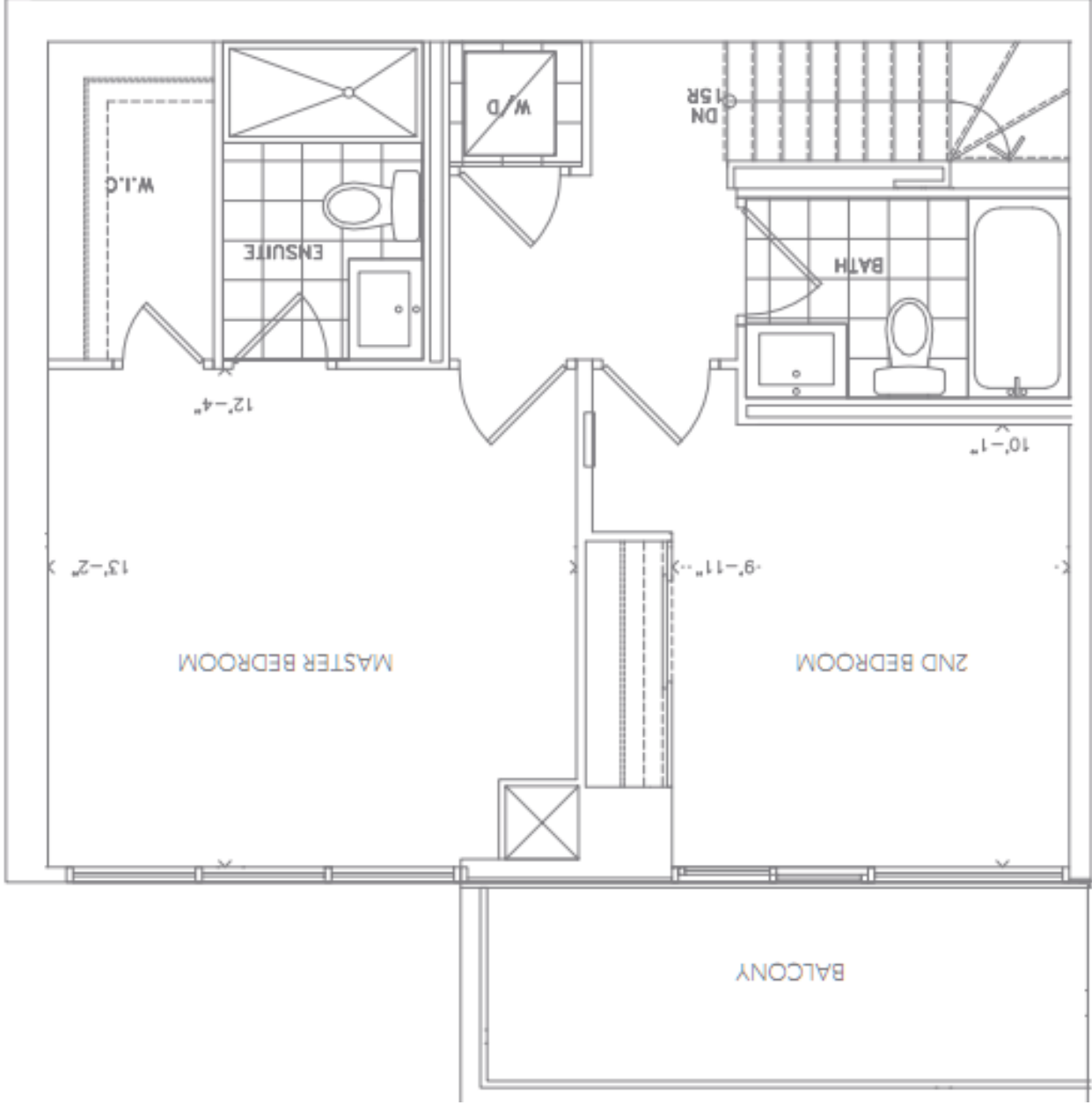

MAIN FLOOR 570 S.F.

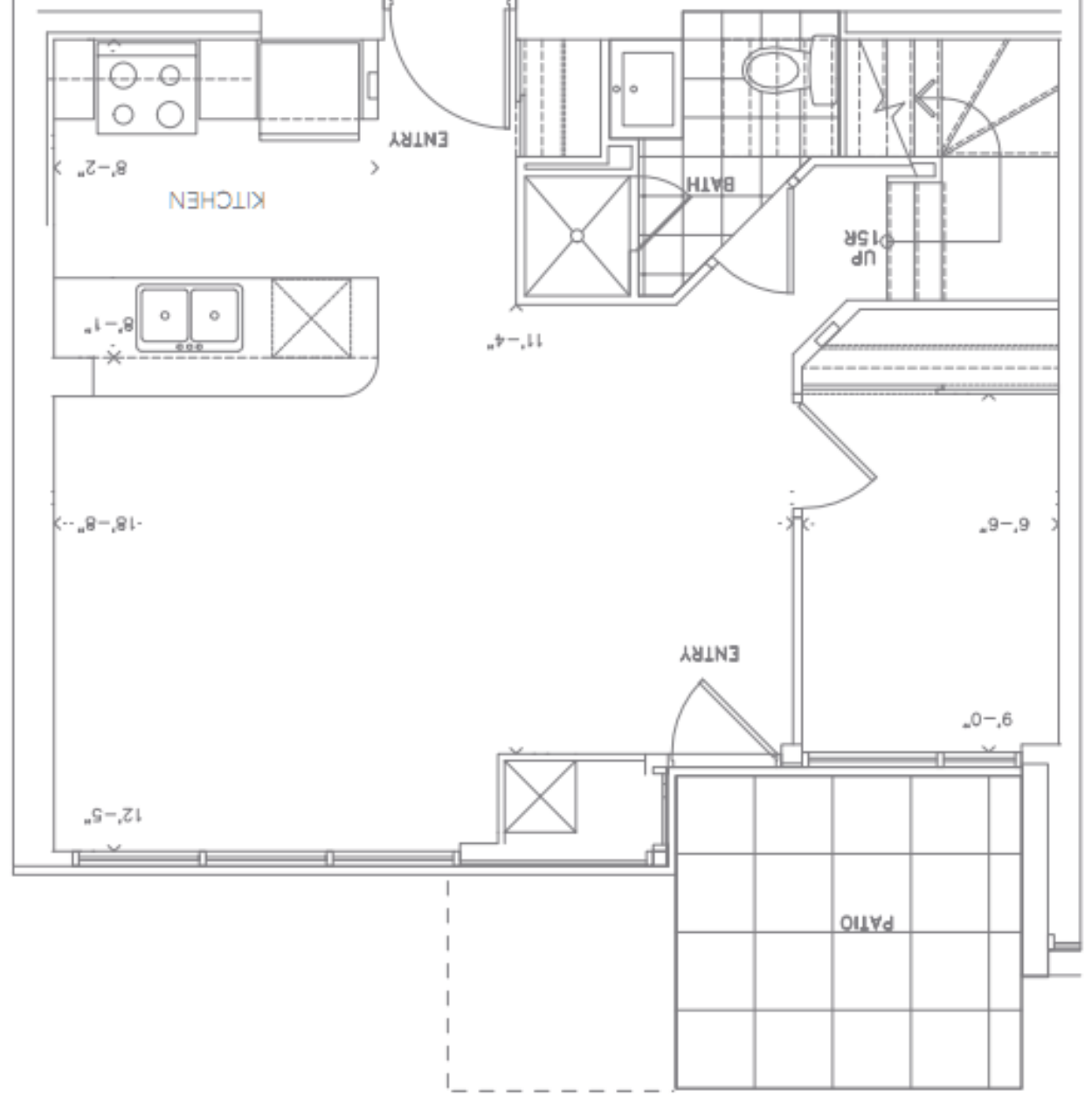

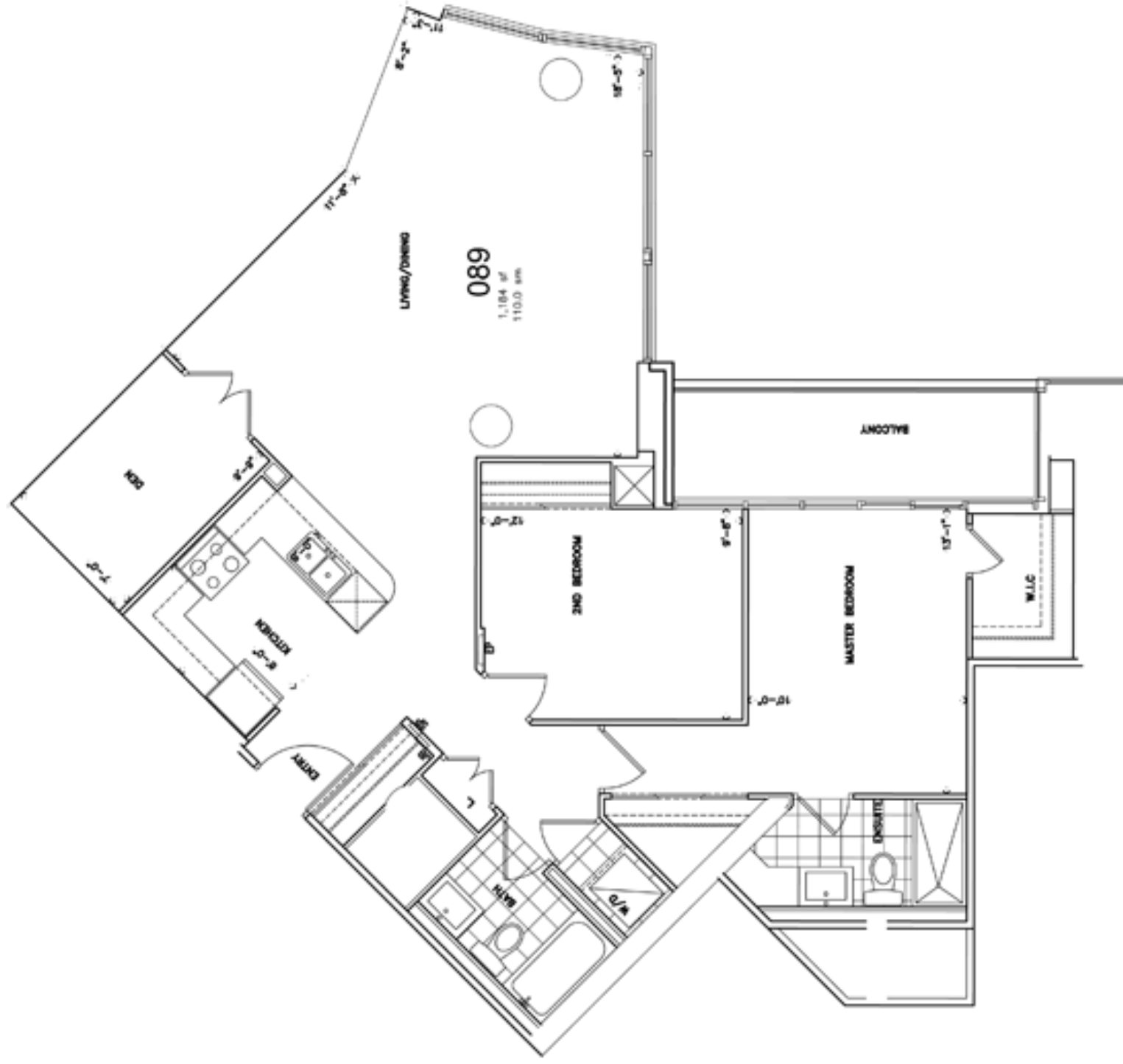

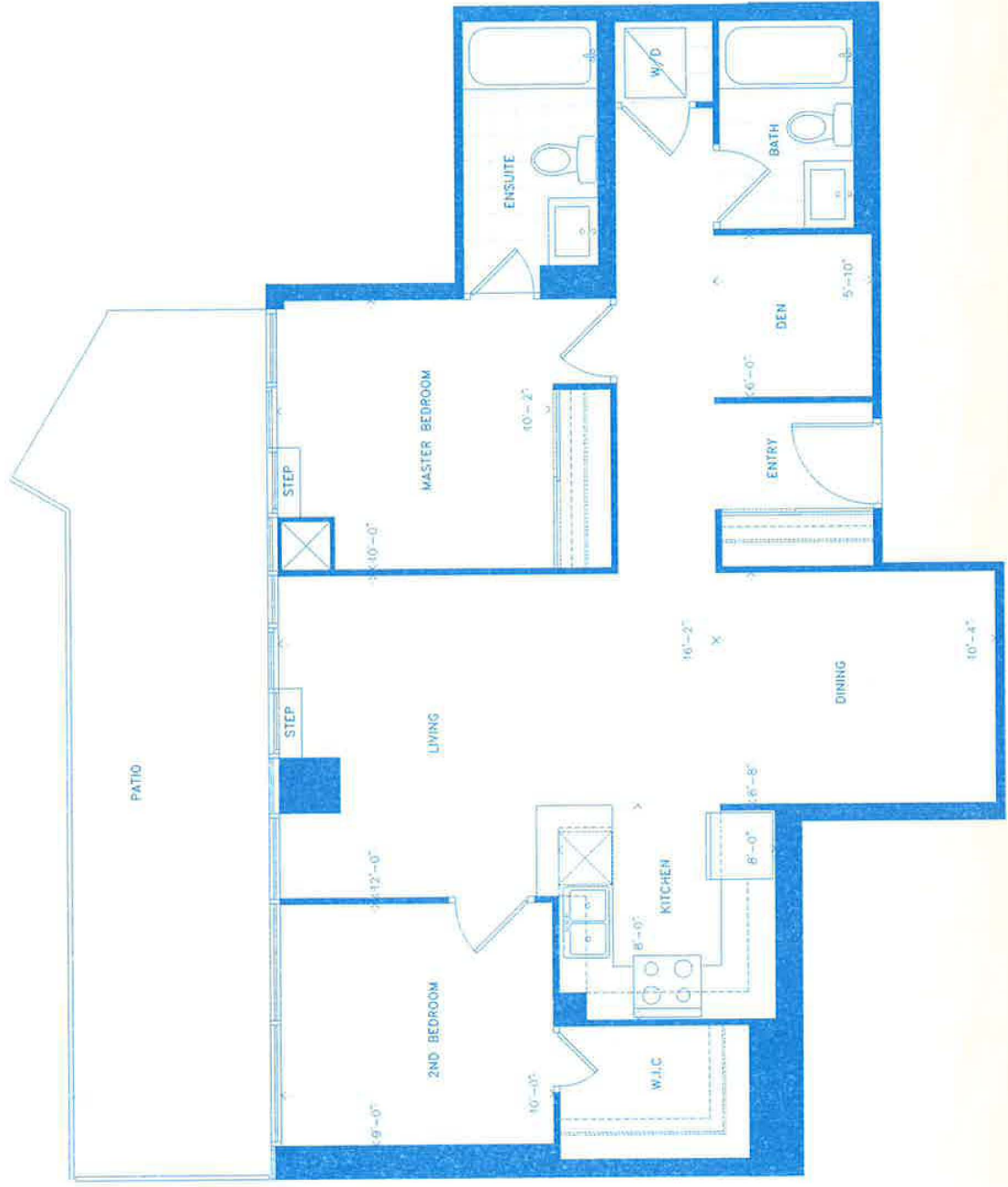

STATE BLUE 921 SQ.FT.
2 BEDROOM + DEN (087-B)

Note: Materials, specifications and floorplans are subject to change without notice. Actual usable floor space may vary from the stated floor area. All room dimensions are shown as approximate. E & O E. July 2007.



FLOOR 3







